

Exploring Coffee Secrets



Castle Series
Coffee machine instructions

Please read the instructions carefully, and keep it well.

Content

1	Introduction.	4
1.1	Welcome.	4
1.2	About the insturction.	4
1.3	Description.	4
1.4	Manufacture instruction.	5
2	Safety.	6
2.1	Purpose.	6
2.2	Sately instruction.	6
2.2.1	Consumer's risk.	6
2.2.2	Hazards to Machines.	8
2.2.3	Dangers of cleaing agents.	9
2.2.4	Health rules.	10
3	Machine description.	13
3.1	Machine introductions.	13
3.2	Technical data.	14
3.2.1	Capacity.	14
3.2.2	Technical sheet.	14
3.3	Accessories.	14
4	Installation and Testing.	15
4.1	Prerequisites.	15
4.1.1	Installation Site.	15
4.1.2	Install coffee bean hopper.	16
4.1.3	Electronic condition.	16

This instruction is for Castle series.

There is difference between picture and products, because of the upgrading of products. Please refer to the actual products.

4.1.4	Water condition.	17
4.1.5	Milk drink requests.	18
4.2	Installation.	18
4.2.1	Coffee machine.	18
4.2.2	Coffee bean hopper installation.	18
4.3	Connection.	19
4.3.1	Water inlet tube connection.	19
4.3.2	Waste water tube connection.	19
4.3.3	Install milk cleaning waste waterpipe.	20
4.4	Power.	20
4.4.1	Coffee machine power.	21
5	Initial working.	21
5.1	Filling.	21
5.1.1	Coffee beans hopper filling.	21
5.1.2	Milk pipe connection.	21
5.2	Power on the coffee machine.	22
5.3	Default Setting.	23
5.4	Grinding settings.	25
5.4.1	Grinding level setting.	26
5.4.2	Calibration of milling powder quantity.	27
5.5	Dumping.	29
5.6	Power off.	30
6	Drink making.	31
6.1	Coffee drink.	31
6.2	Milk drink.	32

6.3	Steam drink.	33
6.3.1	Independent steam operation.	33
6.3.2	Steam and coffee making simultaneously.	34

7 Rinse and maintenance. 36

7.1	Cleaing schedule.	36
7.2	Quick cleaning.	37
7.2.1	Steam Rod Cleaning.	37
7.2.2	System warm-up.	37
7.2.3	Automatic Quick cleaning Setting.	38
7.3	Deep cleaning.	39
7.3.1	Brewer deep clean.	39
7.3.2	Milk deep clean.	40
7.3.3	One-touch maintenance & Setup.	40
7.4	Manual cleaning.	42
7.4.1	Beverage outlet Cleaning.	42
7.4.2	Cleaning inside the machine.	42
7.4.3	Brewing system disassembly and cleaning.	44
7.4.4	Milk pipe disassembling and cleaning.	45
7.4.5	Coffee beans hopper cleaning.	46
7.5	Storage.	47

8 Responsibility and warranty. 47

8.1	User's responsibility.	47
8.2	Warranty and compensation.	48

9 Daily use and maintance. 49

1 Introduction

1.1 Welcome

- This model is the latest fully-automatic coffee machine which is also core patented.
- This instruction introduce how to use and clean this machine. We will not responsible for the lost for the damaging, in case of you did now follow up our instructions.If you need to know more details, please contact with our customer service department.
- This instruction show you how to use and clean the machine. Please use the machine under instructions and keep the instructions for further reading.

1.2 About these instructions

- These instructions are included with the equipment.Always keep these instructions in legible condition at the place of use of the product.
- Modifications to these instructions due to technical advancements reserved. Reprints, translations and reproductions in any form, including exrpts, require written approval from the publisher.The copyright is held by the manufacturer.
- This manual applies to models: Castle series.

1.3 Machine Description

- This machine is a fully automatic coffee machine for making coffee beverages. To make sure it meet the demand of large quantity daily cups, the machine is used for the restaurant, office and other commercial sites.
- The following products can be dispensed depending on the machine equipment: coffee and milk beverages.

- Shell is made from steel and advanced plastic. The design of this machine and all accessories permits the following operator requirements to be observed:
 - Accident prevention regulations for electrical safety in the commercial area;
- The machine has a touch screen for operation.

1.4 Manufacture information

Suzhou Dr.Coffee System Technology Co.,Ltd

#55 Taishan Road, New District,Suzhou City, Jiangsu, China

E-mail : info@dr-coffee.com

Hotline : 400-8977-711

www.dr-coffee.com

2 Safety

Safety is one of our most important features. To make sure that safety device remains useful, you must follow up with the instruction.

2.1 Purpose

This machine and all accessories are intended for the following operating modes:

- Usage of the personnel authorized by the manufacturer;
- Supervised self-service operation (self-service);
- With fixed water connection;
- Pressure-free operation via freshwater and barrel water;
- Permanent installation within dry, enclosed room.

This machine and all accessories are not intended for the following operating modes:

- Areas with high percentage humidity (flash steam area) or outdoors.
- On board of vehicles or in mobile applications (please check with the manufacturer).

2.2 Safety Instructions

2.2.1 Customer's risk



You may get hurt if instructions are not well followed up. Please must observe the following points:

- Please read the instructions carefully before you using it;
- Don't operate it, if the machine is not running normal or damage;
- Changing the safety device is not permitted;
- Touching the high temperature components is not permitted;

- This equipment can be used by children of 8 years and above, and by persons with reduced physical, sensory or mental abilities or of a lesser level of experience and knowledge when they are supervised or have been trained in the safe use of the equipment;
- Children are not allowed to play with the equipment, Children are not permitted to cleaning and maintenance machine;
- Machine is installed at obvious site;
- Self-service use and operation should be supervised by trained personnel. To ensure compliance with maintenance regulations and to resolve usage issue at any time.



Incorrect using the electronic device can lead to shocking. Please read the following points:

- Electrical equipment should only be carried out by trained personnel;
- The machine must be connected with fuse-protected circuit (Connection by selective leakage protection);
- Observe the corresponding low voltage and local and regional safety regulations;
- The connection must obey the regulation to avoid the electronic;
- The supply voltage must match the details on the nameplate;
- Don't touch live parts.



Warning: It must disconnect power supply before repairing.



Warning: Replacing a power cord not provided by our company may present a risk of fire or electric shock.



Warning: Be careful with the drinks additives and residues case allergies.

Please must observe the following points:

- Check the additives in case of allergy listed on the display under self-service operation;

- In self-service applications, look for allergy-causing add-on products that professionals may use.



Scalding Hazard: Risk of scalding in areas where beverages, hot water and steam are made. Do not put your hands under the spout during preparation or cleaning.



Scalding Hazard: High temperature may be present at the spout and the brewing unit. Only allow access to handles pre-designed for production. Clean the brewing unit only after the machine has cooled down.



Crush Caution: There is a risk of crushing by touching any moving parts. Do not reach into the coffee bean hopper, powder hopper or opening of the brewing unit when the machine is switched on.

2.2.2 Hazards to Machines



WARNING: Incorrect use of the coffee machine may result in damage or contamination of the machine. Please observe the following points:

- Install a limescale filter if the carbonate hardness in the water exceeds 8°dKH, otherwise the coffee machine will be damaged by calcification;
- For safety reasons, always pay attention to closing the main water valve (coffee machine with a fixed water connection) after shutting down and turning off the main switch or pulling out the plug;
- Please abide by the relevant low-voltage directives and/or national and local safety rules and regulations;
- Please ensure that the water source is normal before starting the machine, otherwise the pump will be idling;
- Dr. Coffee recommends (at the time of delivery and installation) to install a check valve in the water pipe to avoid water seepage hazard when the hose is ruptured;

- The coffee machine must be cleaned and then restarted after a prolonged shutdown (such as a corporate vacation);
- Protect the coffee machine from weather (frost, humidity, etc.)
- Troubleshooting can only be done by professional technicians;
- Please use original accessories from Dr. Ka company;
- For external visible damage or leakage, please contact customer service immediately for replacement or repair;
- Do not rinse the machine with water or use steam cleaners;
- Do not place the machine on surfaces that may be sprayed with water;
- Only coffee beans can be placed in the coffee bean bin;
- Freeze-dried coffee must not be used, as this will cause the brewing unit to stick;
- If the coffee machine and its accessories are transported at a temperature below 10°C, the coffee machine and its accessories must be left at room temperature for three hours after transport before they are plugged in and turned on. Failure to observe this may result in a risk of short circuits due to condensation or damage to electrical components;
- Always use a new hose set (drinking water/wastewater hose) supplied with the machine, never use an old hose.

2.2.3 Dangers of cleaning agents



Use: Danger of poisoning by ingesting cleaning agents! Please observe the following points:

- Cleaner storage should be kept away from children and unauthorized persons.
- Cleaning agents should not be ingested.
- Do not mix cleaners with other chemicals or acids.
- Never add cleaning agents to the drinking water tank.
- Cleaners and decalcifiers should only be used for their intended purpose (see label).
- Do not eat or drink while using the cleaner.

- Good ventilation and exhaust must be ensured when using cleaning agents.
- Wear protective gloves when working with cleaning agents.
- Wash hands thoroughly and immediately after using cleanser.



Storage: Be sure to observe the following points:

- Store out of the reach of children and unauthorized persons.
- When storing, pay attention to heat, light and moisture.
- Separated from acidic substances.
- Store only in original packaging.
- Keep cleaning agents separate.
- Do not store with food or drink.



Exhaust Disposal: If the product is not available, the cleaning agent and its receptacle must be disposed of in accordance with local laws.



Emergency Advice: Ask the cleaning agent manufacturer (see detergent label) for the telephone number of the Emergency Advice (Toxicology Advice Center).

2.2.4 Health rules



Water: Improper use of water can be a health hazard! Please observe the following points:

- The water must be clean and free from contamination.
- Do not add corrosive water to the coffee machine.
- Minimum carbonate hardness between 5 °dKH or 8.9 °fKH;
TDS:10-80PPM;
- The total hardness value must always be higher than the carbonate hardness.
- The minimum carbonate hardness is 5 °dKH or 8.9 °fKH.

- The maximum chlorine content is 100 mg per liter.
- Ph value 6.5~7 (pH neutral).
- Machines using drinking water tanks (internal & external):
 - Fill the drinking tank with fresh water every day;
 - Clean the drinking water tank thoroughly before adding water.



Coffee: Incorrect use of coffee can be detrimental to your health! Be sure to observe the following points:

- Check for damage before unpacking.
- Do not add more than one day's worth of coffee beans.
- Close the coffee bean compartment cover immediately after adding coffee beans.
- Coffee should be stored in a dry, cool and dark place.
- Coffee should be stored separately from detergents.
- The oldest product purchased should be used first ("early in, early out" principle).
- Please use it up within the warranty period.
- The package should be well sealed after opening to keep the product in the package fresh and prevent it from contamination.



Milk: It will harmful for the healthy with incorrect operation of milk! Be sure to observe the following points:

- Don't use raw milk.
- Only pasteurized and heat treated milk.
- Only homogenize milk.
- Please use the cold milk which temperature is around 4-10 °C .
- Wear gloves during milk treatment.
- Only milk from original package.
- Filling milk into original package is not permitted. Clean the milk container before filling.
- Check the package.
- The filling capacity of milk is no more than the daily usage.

- Close the cover of milk container and cooler after filling (Inside / Outside) .
- Keep the milk in dry, cold and enclosed room.(Highest temperature 7℃)
- Use fresh milk.
- Use beans during the shelf-life.
- Seal package after opening it, to prevent it from pollution.

3 Machine description

3.1 Machine introductions

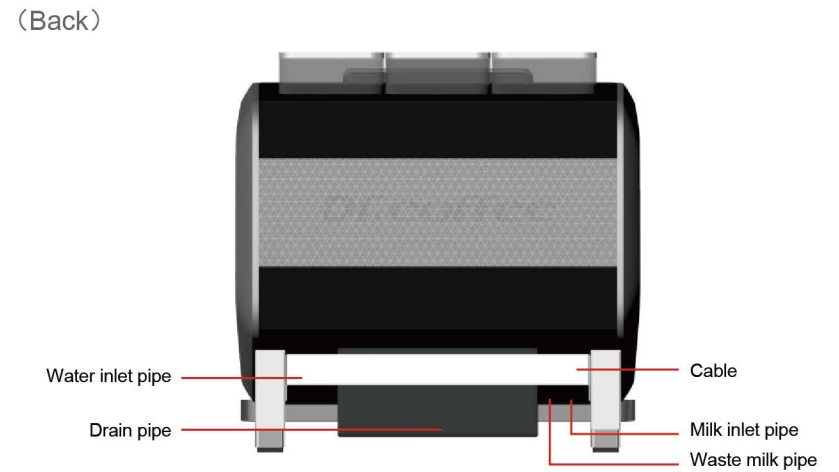
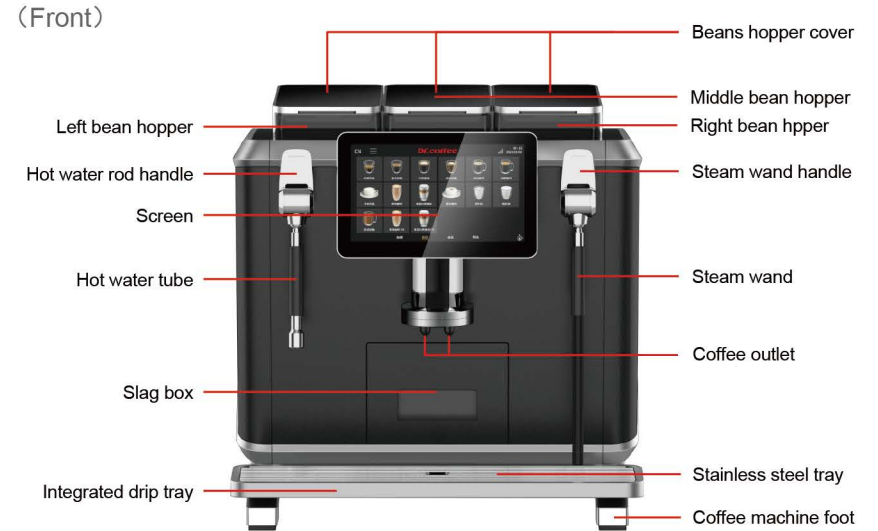

3.2 Technical Parameters

3.2.1 Output capacity

Cups per hour based on DIN18873-2:

Advised daily output	300 Cups	
Cups per hour	Single	Double
Espresso(50ml)	90 Cups	130 Cups
Americano(210ml)	90 Cups	110 Cups
Cappuccino(210ml)	65 Cups	85 Cups
Hot water output per hour	40L	
Coffee bean hopper capacity	About 1000g*2+700g	
Grounds container capacity	600g	

3.2.2 Specification parameters

Coffee machine	380V~50Hz 7920W
Connection tube set	φ6mm Quick-connect pipe
Connection water pressure	0.08-0.6MPa(0.8-6bar)
Coffee machine W*D*H	64*56*59cm
Coffee machine N.W	51 kg

3.3 Default accessories

The fully automatic coffee machine is supplied with the following accessories:

Beans hopper	x3 Pcs	Quick start guide	x1 Pcs
Water inlet pipe	x1 Pcs	Milk inlet pipe	x2 Pcs
Waste water connection	x1 Pcs	Cleaning Box	x1 Pcs
Waste milk pipe	x1 Pcs		

4 Installation and testing

➤ Professionally trained personnel can perform the following operations.

4.1 Placement requirements

4.1.1 location



The following conditions are suitable for placing the coffee machine. Failure to guarantee these conditions could damage the machine. Be sure to abide by the following conditions:

- The installation surface must be stable and flat, and will not deform under the condition of bearing the weight of the coffee machine;
- Do not place it near a hot surface or heat source;
- The coffee machine is located so that trained personnel can look after it at all times;
- The distance between the energy interface specified on the site installation drawing and the machine location shall not exceed 1m.
- Reserve some space for maintenance work and operation:
 - Leave enough space above to fill the coffee beans;
 - Keep a minimum distance of 5cm between the back of the device and the wall (air circulation);
 - Observe valid regulations on local cooking techniques.

4.1.2 Climate conditions



The following climatic conditions are suitable for placing the coffee machine. Failure to guarantee these conditions may damage the machine. Be sure to abide by the following conditions:

- Ambient temperature maintained at +10°C to +35°C (50°F to 96°F)
- Relative air humidity up to 80 % rF;
- The coffee machine is designed for indoor use only. Do not use outdoors, protected from weather (rain, snow, frost)!



Low temperature storage requirements:

- If the coffee machine in normal use needs to be stored or transported, when the ambient temperature is lower than 0°C, the waterway must be emptied first.

4.1.3 Power conditions

- The electrical connection must be made in accordance with the relevant regulations of the country in which it is used. The voltage at the installation site must match the voltage given on the nameplate.



Warning electric shock: Danger of electric shock!
Be sure to observe the following points:

- It must be protected by a fuse with the amperage value stated on the nameplate!
- All phases of the equipment must be able to be disconnected from the power grid, and the lines connected to the power line must be reliably grounded;
- The electrical equipment on site must be connected according to IEC 364 (DIN VDE 0100).
- Do not operate the machine with a damaged power cord. Immediately replace damaged power cords or plugs by professional technical service personnel;

- Dr. Coffee recommends that you do not use extension cables! If an extension cable must be used (minimum cross-section: 1.5 mm²), please observe the manufacturer's data (instruction manual) for the power cord and local regulations;
- Route the power cord so that people cannot trip over it. Do not let the power cord pass through sharp corners or hang in the air, and do not pinch cables. In addition, the cables must not be placed over high temperature objects and must be protected from oils and aggressive cleaning agents;
- Do not lift or pull on the device by the power cord. Do not pull the plug out of the socket by pulling on the power cord. Never touch the power cord or plug with wet hands! Never insert wet plugs into sockets!

4.1.4 Water conditions



Poor quality raw materials and poor water quality can damage the machine. Be sure to observe the following points:

- The water must be clean and contain no more than 100 mg of chlorine per liter;
 - Do not add corrosive water to the coffee machine;
 - Carbonate hardness must not exceed 5~6°dKH (German carbonate hardness) or 8.9~10.7°fKH (French carbonate hardness) and the total hardness value must always be higher than the carbonate hardness.
 - Minimum carbonate hardness is 5°dKH or 8.9°fKH. pH must be between 6.5~7;
 - Be sure to use the new hose kit (clean water/waste hose) supplied with the machine.
- The water supply must be connected in accordance with the current regulations and the regulations of the country in which it is used. If the machine is connected to a newly installed water line, the water line and inlet hose must be rinsed thoroughly to prevent stains from entering the machine.
 - The coffee machine must be connected to a drinking water line with a throttle valve installed. Fit it to the pressure reducer on the tap (adjusted to 0.3 MPa (3 bar)) via the installed pressure hose and threaded connection G 3/8".

4.1.5 Milk drink requests

- The temperature of milk should be around 4 - 10 °C ;
- The minimum liquid level of the milk tank (or bottled milk) shall not be less than 90cm on the table top ;
- Dr.coffee cooler is suggested to supply with coffee machine.

4.2 Install

4.2.1 Coffee Machine

- Open the carton, take out machine and spare parts. The machine and all accessory units are only permitted to be installed and stored in frost-free locations.

4.2.2 Install coffee bean hopper

Step 1: Place coffee bean box 1 on the top cover bean box seat, and turn the handle counterclockwise until the bean box door is fully open ;



Step 2: As shown in the figure, repeat step 1 to install the remaining 2 bean boxes in place, and then cover the bean boxes.



✓ Coffee bean hoppers installation completed.

4.3 Connection

4.3.1 Connect the water inlet

Step 1: Remove the plug/stopper from the water inlet of the coffee machine, and tighten the nut anticlockwise to fix it;

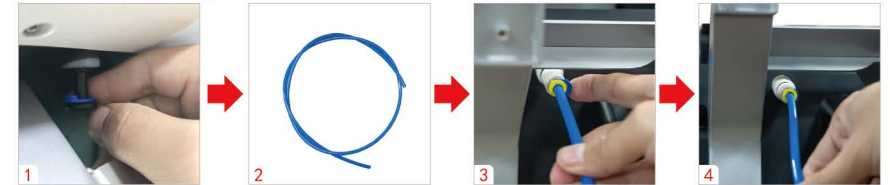

Step 2: Connect the other end of the water inlet pipe to tap water.



✓ Water inlet tube installation completed.

4.3.2 Install the waste pipe

Step 1: As shown in the figure, insert the waste water pipe into the metal hose band and insert it into the water storage tray at the bottom of the coffee machine. Then use a flat-head screwdriver to lock the metal hose band.



Step 2: Place the outlet of the waste pipe above the waste bucket (or waste pool).



✓ Waste water pipe installation completed.

4.3.3 Milk cleaning drainage pipe installation

Step 1: Take out the coffee-colored hose as shown in the picture and insert one end of the hose into the bottom Waste milk / Waste liquid connector as shown in the picture.



Step 2: Put the outlet of pipe into the barrel or waterpot.



✓ Milk cleaning drainage pipe installation completed.

4.4 Power source

➤ The supply voltage must correspond to the description on the nameplate.

➤ The power cord of the coffee machine must be connected to the power supply with an air protection switch by a professional electrician.

4.4.1 Coffee machine power supply

As shown, connect the power cord to the air protection switch.

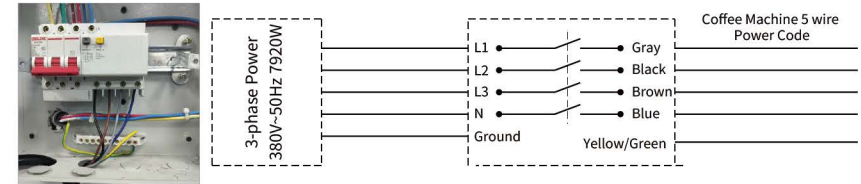

✓ The power connection of the coffee machine is completed.

5 First run

➤ Professionally trained personnel can perform the following operations.

5.1 Filling

5.1.1 Fill coffee bean

Open the lid of the coffee bean storage box and check if the bean box switch is turned on. Add the coffee beans into the bean container and then close the lid.



5.1.2 Milk pipe connection

Step 1: Insert the white transparent silicone tube that comes with the coffee machine into the milk connector at the bottom of the coffee machine as shown in the picture below.



Step 2: Insert the other end from the refrigerator connector into the milk (it is recommended to use the Dr. Coffee refrigerator).



√ Milk pipe connection is complete.

5.2 Power on machine

As shown in the figure, push the beverage outlet up to the top, and then remove the slag box, and then press the power switch inward, and finally put the slag box back.



√ Coffee machine power on.

5.3 Default setting

Step 1: First start, Initial setup.

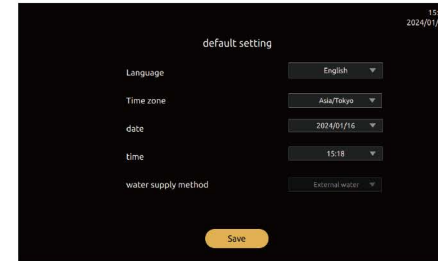

Step 2: Click the menu option, enter the corresponding initial value.

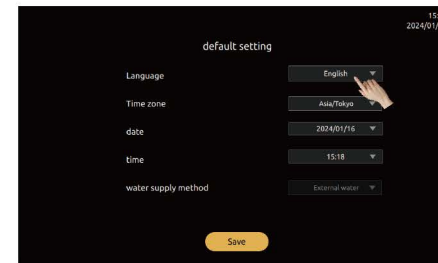

Step 3: Click the "Save" button to next step.

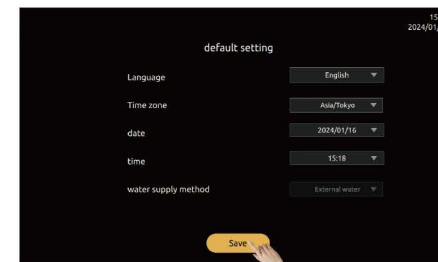

Step 4: Machine Starting.....

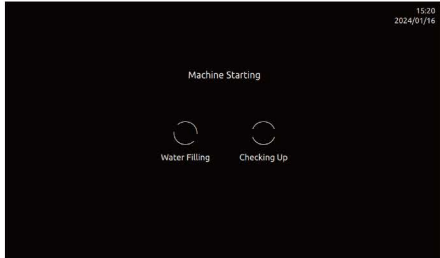

Step 5: After the self-check is complete, the coffee machine enters the main screen and the system is heating, please wait for...

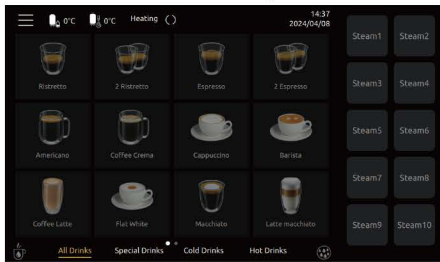

Step 6: After the system is heated, enter the quick quick rinse selection interface, If no operation is performed within 10 seconds, quick cleaning is performed by default. When finished, the main screen will be displayed.

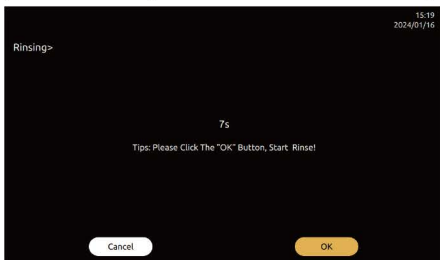

Step 7: Power on complete, machine ready for coffee.



√ Default setting complete.

5.4 Grinding settings

Step 1: Click on the shortcut menu icon at the top of the screen to enter the shortcut menu interface.



Step 2: Click service menu, enter passwords into Eng. Setting.

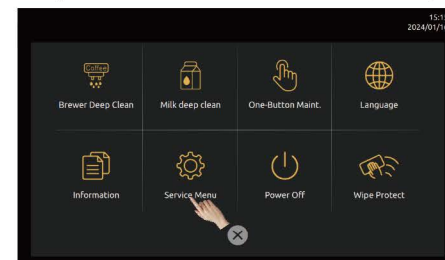

Step 3: Click "Grounds Cal." into grinding calibration.

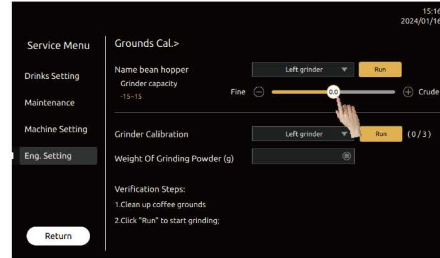
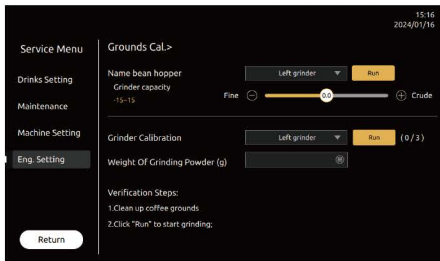
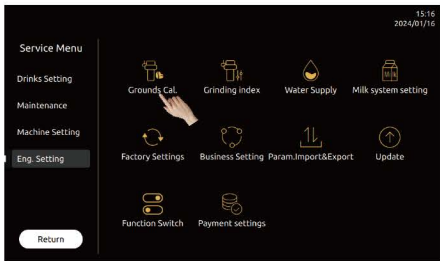

Step 3: Click "Start" to adjust the grinding degree of the coffee machine (after completing the grinding degree gear adjustment, please perform powder (after completing the grinding degree gear adjustment, please perform powder volume calibration before confirming the grinding degree status of the beverage production);

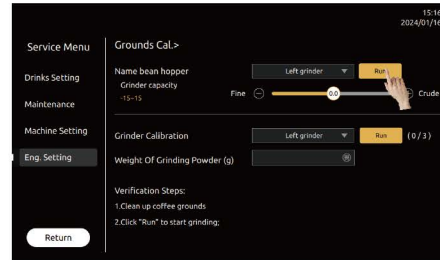

√ Grinding level adjustment completed.

5.4.1 Grinding level setting

Step 1: Choose the grinder.

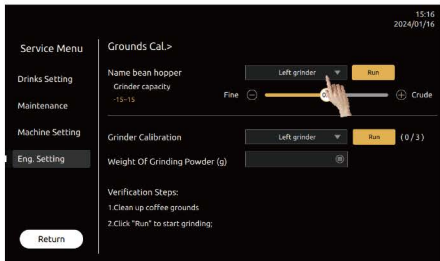

Step 2: Adjusted the level;

5.4.2 Calibration of milling powder quantity

Step 1: Go to "Shortcut Menu" - "Service Menu" - "Engineering Settings" - "Grinding System Settings". And select the grinder to be verified in the column of "Grinder Calibration";

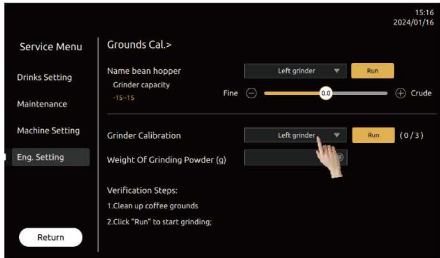

Step 2: Remove the slag container and place it on the electronic scale for zeroing and then put it back;



Step 3: Click "Run" to get powder.

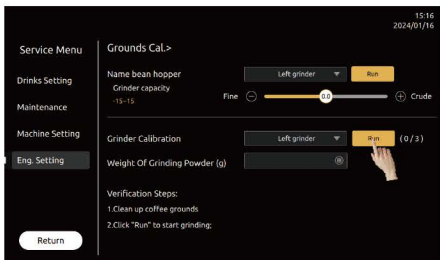

Step 4: When the device finishes taking powder at one time, take out the dregs container and weigh the powder, then clear it and put it back;



Step 5: Enter the powder value and click "Save" to complete grinder calibration.

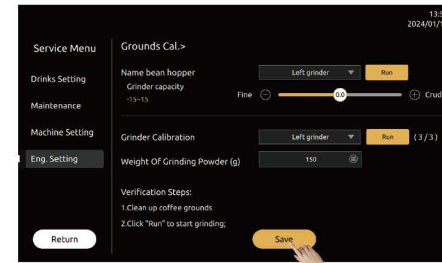

✓ Grinding calibration complete.

5.5 Dumping

Step 1: As shown, push the drink outlet to the top, remove the grounds container, empty it and put it back.

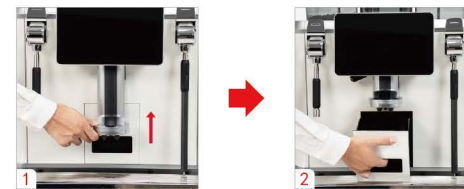

Step 2 (when the appliance is switched on and in use for slag emptying): Follow the interface prompts (Slag box removal time exceeding 10s triggers the confirmation screen) to correctly click on the "Not emptied"/"Emptied" slag box option.

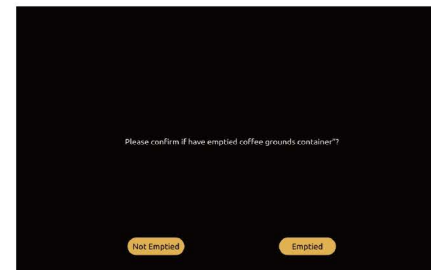

5.6 Power off machine

Step 1: Click the icon and shortcut at the top of the screen, then into the menu.



Step 2: Click the option "Power Off" at the bottom of display.

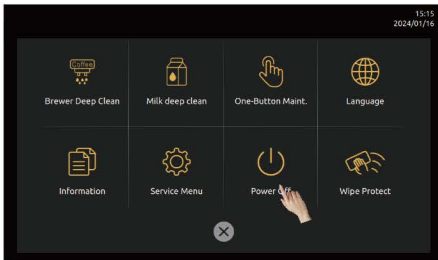

Step 3: The screen pop-up prompts. Are you "power off", click "OK" machine turns to power off mode,click"Cancel"to cancel this operation, the screen is off but light is still on(press the screen more than 3 seconds to wake up the machine).

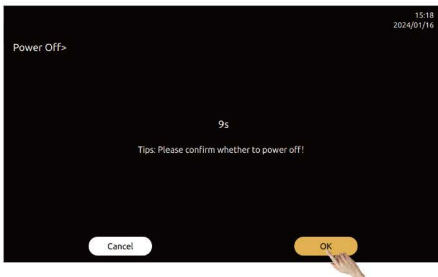

Step 4: Take out the grounds container, and then put it back in place.
Note: Do not power off the machine directly in the startup state, so as not to cause damage to the machine.



✓ Coffee machine power off.

6 Drink making

➤ The following steps can be operated by end users.

6.1 Coffee drink

➤ For example: Make a cup of "Espresso".

Step 1: Click "Espresso", then coffee under processing.



Step 2: The beverage parameter adjustment interface appears. After adjusting and confirming, click "Start Making" to proceed with the beverage (Only work under adjustable mode)

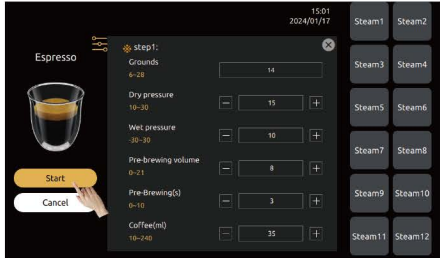

Step 3: Drink under processing...click: Cancel, stop coffee instantly.



✓ Coffee drink completed.

6.2 Milk drink

▶ For example :A cup of “Cappuccino”.

Step 1: Click “Cappuccino”, then coffee under processing.



Step 2: The beverage parameter adjustment interface appears. After adjusting and confirming, click "Start Making" to proceed with the beverage (Only work under adjustable mode)

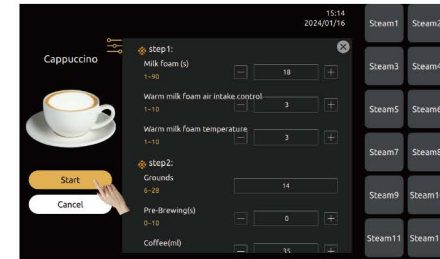

Step 3: Drink under processing...click: Cancel, stop coffee instantly.



✓ Milk coffee is completed.

6.3 Steam Drink

6.3.1 Steam

Step1: Click“Steam”, machie starts working.



Step 2: Under process, click“Cancel”stop working.



√ Steam making completed.

6.3.2 Steam and coffee making simultaneously

Step 1: Click black coffee, coffee is under processing.



Step 2: Drink making is under processing, click “☑️” ,the steam making interface would pop up at the right of screen, coffee and steam are processing at the same time.

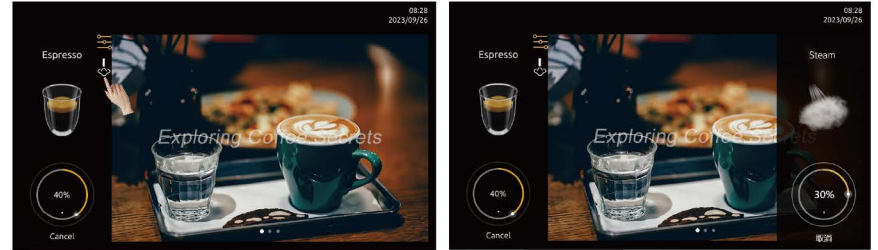

Step 3: Drink under processing...click: Cancel, stop coffee instantly.



7 Rinse and maintenance

- The following steps must be operated to the personnel authorized by the manufacturer.

7.1 Cleaning schedule

Dr.coffee commercial coffee machine cleaning schedule							
	Daily	Weekly	Demand	Required	Mandatory	Item	Info
Quick clean	☺		☺			Steam rod clean	▶ P37 (7. 2. 1)
	☺		☺			System warm up	▶ P37 (7. 2. 2)
	☺		☺			Automatic Quick cleaning Setting	▶ P38 (7. 2. 3)
Deep clean	☺			☺	●	Brewer deep clean	▶ P39 (7. 3. 1)
	☺			☺	●	Milk deep clean	▶ P40 (7. 3. 2)
			☺		●	One-button maint & Setup	▶ P40 (7. 3. 4)
Manul clean						Beverage outlet clean	▶ P42 (7. 4. 1)
	☺	☺				Machine interner clean	▶ P42 (7. 4. 2)
		☺				Brewer disassembly and clean	▶ P44 (7. 4. 3)
		☺				Milk pipe disassembly and clean	▶ P45 (7. 4. 4)
		☺				Bean hopper clean	▶ P46 (7. 4. 5)
	Interpretation						
Daily	Clean at least once per day, possibly more often if needed						
Weekly	Clean at least once per week, possibly more often if needed						
Demand	Clean if required or dirty if required						
Required	When the machine shows prompts for cleaning						
Mandatory	After the machine jumps out of the prompt, it must be cleaned strictly accordance with the requirements to avoid irreversible machine damage.						

7.2 Quick cleaning

7.2.1 Steam Rod Cleaning

Step 1: After making a steam drink, wipe the steam rod with a clean damp towel;



Step2: Push up or pull down the steam rod handle to clean.



7.2.2 System warm-up

Step 1: Click the Warm-up shortcut icon in the bottom right corner of the screen (when the warm-up shortcut switch is on).



Step 2: Click "Confirm" (or the device will start automatically when the timer runs out);

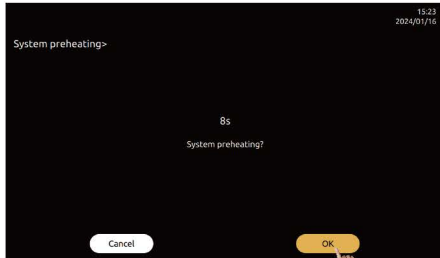

Step 3: The system is warming up, please wait...

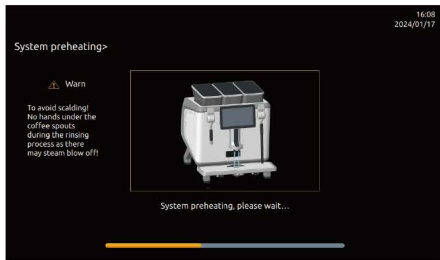

√ Warm-up completed.

7.2.3 Automatic Quick cleaning Setting

Step 1: Go to: "Quick Menu" - "Service Menu" - "Machine Settings" - "Maintenance Settings";

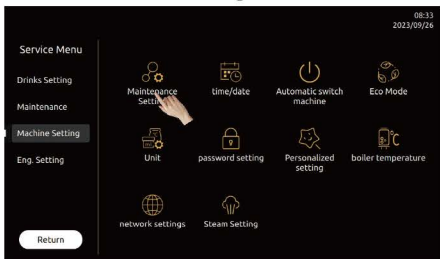

Step 2: Set the interval of the desired quick rinse items (corresponding to the set time after the system is out of use). (i.e. rapid rinsing is carried out automatically) "Confirm";

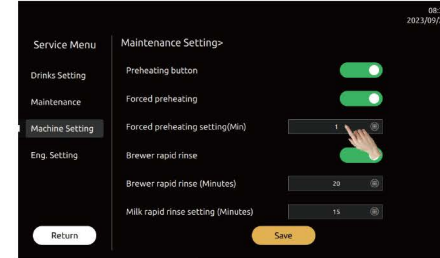

Step 3: Click "Save" button to finish saving the above settings;

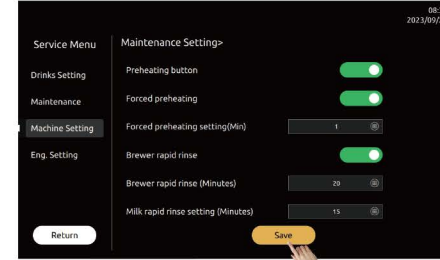

√ Rapid rinsing setup complete.

7.3 Deep cleaning

7.3.1 Brewer deep clean

Step 1: Click the shortcut menu icon at the top left of the screen to enter the Service Menu screen;

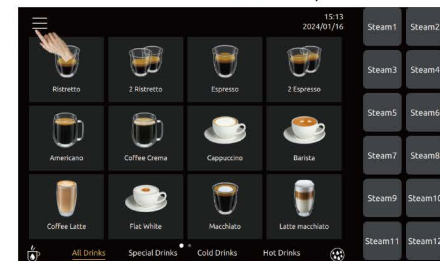

Step 2: Click on the screen " Deep Cleaning", then follow the prompts.

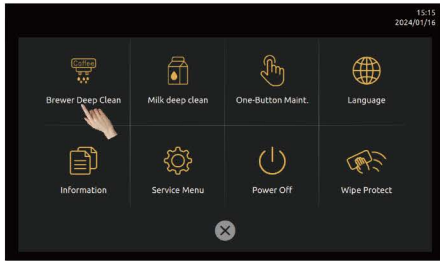

7.3.2 Milk deep clean

Step 1: Click the shortcut menu icon at the top left of the screen to enter the Service Menu screen;



Step 2: Click on the screen " Milk System Deep Cleaning", then follow the prompts.

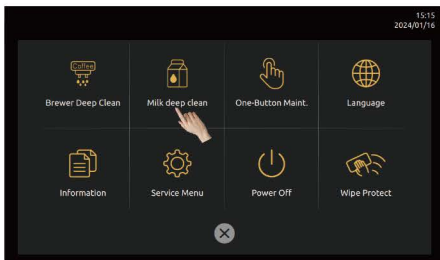

7.3.3 One-touch maintenance

Step 1: Click the shortcut menu icon at the top left of the screen to enter the Service Menu screen;



Step 2: Click on the screen " One Touch Maintenance", then follow the prompts.

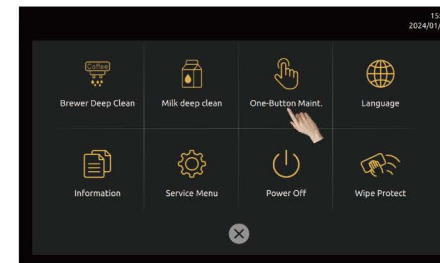

Step 4: When the setting time is reached, the coffee machine automatically pops up the cleaning interface (before entering the interface), following the prompts.

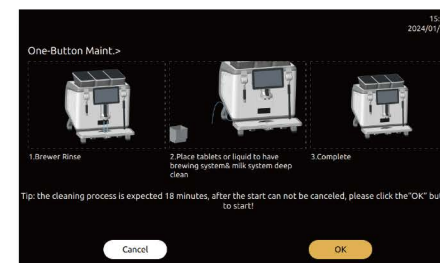

7.4 Manual cleaning

7.4.1 Beverage outlet Cleaning

Step 1: Press the coffee outlet with both thumbs, push forward, and then remove the drink outlet;



Step 2: As shown, remove the sealant and clean it under running water.

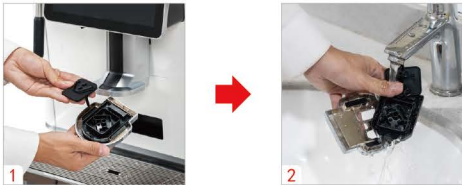

Step 3: After cleaning, install the beverage outlet as shown in the following figure.



7.4.2 Cleaning inside the machine

Step 1: Remove the slag box and empty the waste water and slag;



Step 2: Clean the inside corners of the machine, first with a damp towel and then with a towel dry;

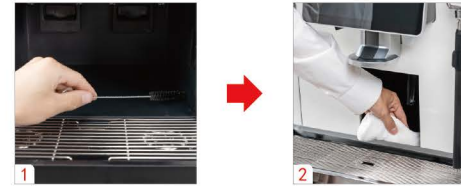

Step 3: Rinse the container with water and dry it with a towel;



Step 4: Put back the grounds container ;



Step 5: When cleaning at power on, the interface will pop up to confirm whether to empty the Dump Box or not, click "Not Empty" or "Emptied" accordingly.

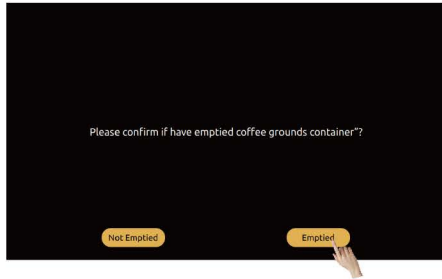

7.4.3 Brewing system disassembly and cleaning

Step 1: As shown, push the drink outlet up to the top and remove the grounds container;

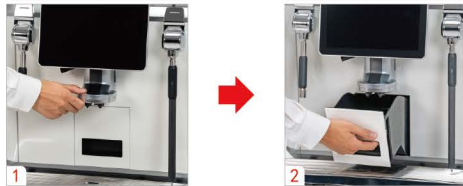

Step 2: Push the clips inwards with your fingers as shown, then press down on the cartridge, then grasp the body of the brewer with your hand and remove the brewer outwards;

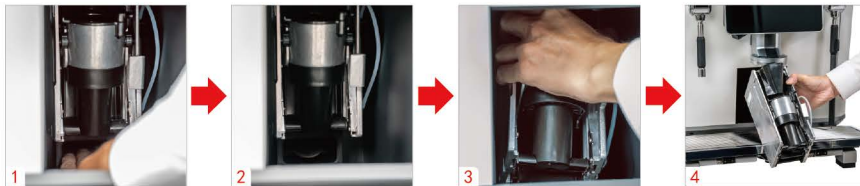

Step 3: Rinse the brewer with water and clean the brewer filter with a brush;



Step 4: Attach the brewer to the cartridge and push up on the cartridge (a "click" will indicate that it is in place);

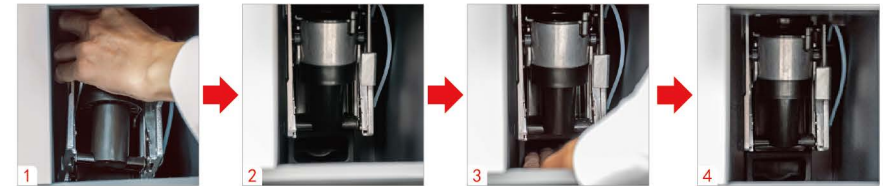

Step 5: Put back the grounds container and close the coffee machine door;



Step 6: When the brewer installation is carried out in the boot state, the interface pops up the brewer self-test pop-up window, click 'self-test'.

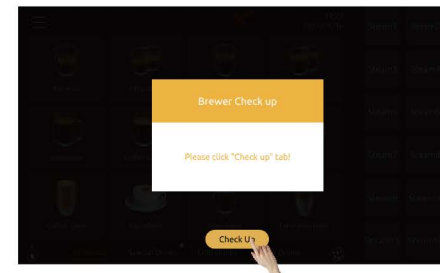

7.4.4 Milk pipe disassembling and cleaning

Step 1: Remove the milk tube at the arrow of the bottom cover for cleaning as shown in the figure;



Step 2: Connect the clean milk pipe.

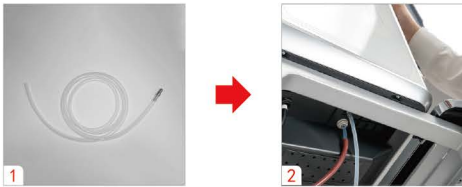

7.4.5 Coffee beans hopper cleaning

Step 1: Open the cover of the coffee beans hopper and turn the handle clockwise to remove it;



Step 2: Clean and dry the bean compartments and put them back into the coffee machine.



7.5 Storage

- Once the device is decommissioned, please observe the following placement conditions:
 - Usage of the personnel authorized by the manufacturer;
 - Relative air humidity max. 80 % rF.
 - If the coffee machine and its accessories are transported at temperatures below 10°C, they must be left at room temperature for three hours after transport before being connected to the mains and started up. If this is not observed, there may be a risk of short circuits due to condensation or damage to electrical components.
 - If a coffee machine in normal use needs to be stored or transported, when the ambient temperature is below 0°C, the water path must be cleared first.
 - After the coffee machine has been out of service for an extended period of time (e.g. during company holidays), it must first be cleaned before being put into use again.

8 Liability and Warranty

8.1 User Responsibilities

- The user must ensure that the safety device is regularly maintained and inspected by Dr. Coffee's technical service personnel, its authorized personnel or other authorized personnel.
- Quality defects must be notified in writing to Dr. Coffee within 30 days. For hidden defects, this period is extended to 12 months after installation (work report, handover record).
- Parts involving safety, such as safety valves, safety thermostats, water boilers, etc., are not allowed to be repaired. Said parts must be replaced!
- These measures are carried out by the customer service technicians of Dr. Coffee or by the service partner when maintenance is performed.

8.2 Warranty and liability

- If personal injury or property damage is caused due to the following reasons, our company will not be liable for warranty and compensation:
 - The machine is not being used correctly as specified.
 - Incorrect installation, commissioning, operation, cleaning and maintenance and associated optional equipment.
 - Maintenance intervals not respected.
 - Continue to use this machine if safety devices and guards are damaged, incorrectly installed, or failed.
 - Failure to comply with the instructions in the instruction manual regarding the preservation, installation, operation, use and maintenance of the machine Safety Instructions.
 - The machine is not being used under normal conditions.
 - Repairs are not performed correctly.
 - Not use genuine parts from Dr. Coffee.
 - Use a cleaner not recommended by Dr. Coffee.
 - Damage caused by foreign objects, accident, vandalism and force majeure.
 - Insert foreign objects into the machine or open the machine casing with foreign objects.
- The manufacturer assumes all possible liability for damages only if the prescribed service and maintenance intervals are observed and original spare parts ordered from the manufacturer or authorized suppliers are used.
- Dr. coffee's "General Terms of Business" apply.

9 Precautions for daily use and maintenance

- Please do not add water to the coffee bean hoppers;
- During the operation of the coffee machine, please do not open the door of the coffee machine forcibly, take out the grounds box, drip tray, water tank and other components;
- The external water tank can only be filled with pure water at room temperature, please do not add hot water or ice water;
- It is recommended to use coffee beans with medium roast or medium dark roast and not too oily. It is not recommended to use dark roasted or charcoal roasted and very oily coffee beans;
- If you need to change the type of coffee beans and powder, it is recommended to do calibration again;
- When the beverage flows out, please do not put your hand at the outlet of the coffee machine to avoid burns;
- When cleaning the machine, please do not use a brush or cleaning agent, so as not to damage the appearance of the coffee machine, please wipe it with a soft cloth dampened with water;
- Please do not exceed the MAX line for adding beans hoppers to the bean hopper and powder hoppers. If there is no MAX line, fill it with 8 points.
- During the coffee making process, self-checking and resetting process, and automatic cleaning process, please do not cut off the power supply;
- According to the height of the coffee cup, adjust the height of the coffee outlet appropriately to avoid the splashing of beverages such as coffee and hot water;
- Every day after the machine is turned off and stopped for use, please empty the coffee grounds and waste water in the machine and clean it; if you use a machine with an external water supply, please do not use the machine after the external water source is cut off.
- Every day after the machine is turned off and stopped for use, please empty the coffee grounds and waste water in the machine and clean it;
- If you use a machine with an external water supply, please do not use the machine after the external water source is cut off.